



202831

Husillo y tuerca para tornillo de banco de guía redonda 201251



DETALLES DEL PRODUCTO

- Husillo y perno de repuesto para tornillo de banco de guía redonda 201.

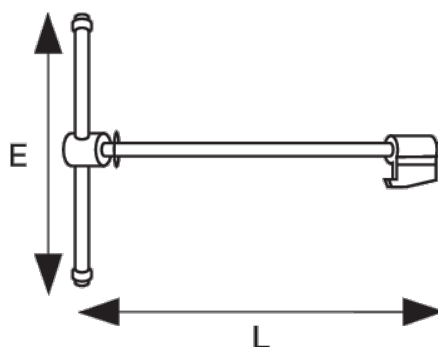

ATRIBUTOS DE PRODUCTO

Producto		E	L	
202831	125 mm	275 mm	364 mm	2200 g