



206841

Ersatz-Spindel und -Mutter für
Vierkant-Schraubstöcke
207061/216061



PRODUKTDDETAILS

- Ersatz-Spindel und -Mutter für Schraubstöcke 207041/207071 und 216 mit Vierkant-Schlitten

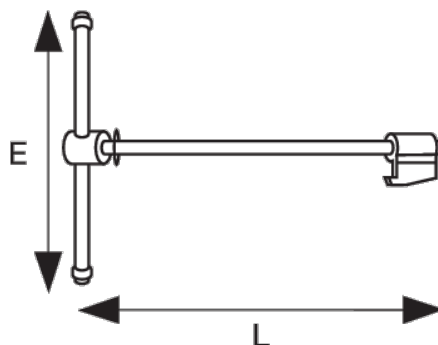

PRODUKTEIGENSCHAFTEN

Produkt		E	L	
206841	150 mm	310 mm	432 mm	2200 g