



206831

Husillo y tuerca para tornillos de
banco de guía cuadrada
207051/216051



DETALLES DEL PRODUCTO

- Husillo y tuerca de repuesto para tornillos de banco de banco de guía cuadrada 207041/207071 y 216.

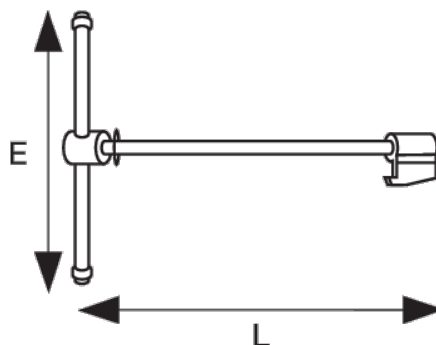

ATRIBUTOS DE PRODUCTO

Producto		E	L	
206831	125 mm	275 mm	352 mm	1400 g