



206841

**Husillo y tuerca para tornillos de banco de guía cuadrada
207061/216061**



DETALLES DEL PRODUCTO

- Husillo y tuerca de repuesto para tornillos de banco de banco de guía cuadrada 207041/207071 y 216.

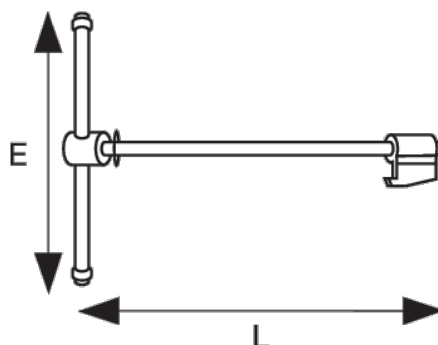

ATRIBUTOS DE PRODUCTO

Producto		E	L	
206841	150 mm	310 mm	432 mm	2200 g