



L-BOOK-1 Linterna SMD, 500-1000 lúmenes







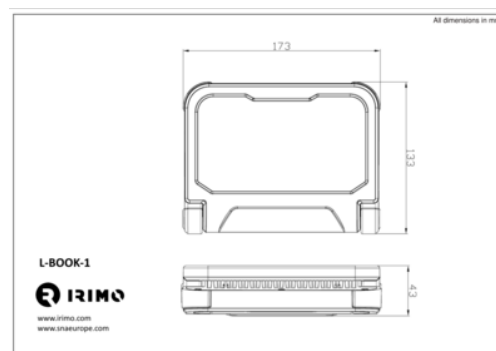



DETALLES DEL PRODUCTO

- 27 LED SMD.
- Dos opciones de intensidad: 500 lm/1000 lm.
- Pata trasera que se pliega 270° para usar un soporte o un gancho.
- Carcasa ABS resistente a los impactos y a varios líquidos presentes en los talleres.
- Función de base de carga.
- Batería de litio de 3,7 V y 4000 mAh.
- Hasta 6 horas de funcionamiento.
- Incluye cable de carga micro USB de 1 m.
- Temperatura del color: 6000°K.
- IP54/IK08.
- Índice de reproducción cromática (CRI) >80
- CE-EMC/RoHS/Reach.



ATRIBUTOS DE PRODUCTO

Producto						LED				
L-BOOK-1	500-1000 lm	✓	X	3/6 h	3 h	SMD	54	6000 K	182 x 142 x 52 mm	400 g