



206-125

### Husillo y tuerca de repuesto para tornillo de banco 207-125



#### DETALLES DEL PRODUCTO

- Husillo de recambio para mordazas de guía cuadrada 207-100 / 207-150

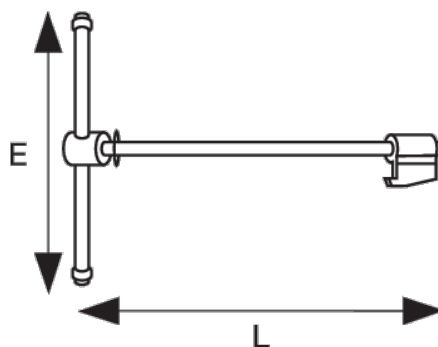

#### ATRIBUTOS DE PRODUCTO

Producto		<b>E</b>	<b>L</b>	
<b>206-125</b>	125 mm	220 mm	188 mm	920 g