



202811

Spindle & Nut for Round Guide
Bench Vice 201231



PRODUCT DETAILS

- Spare spindle and nut for round guide vice 201

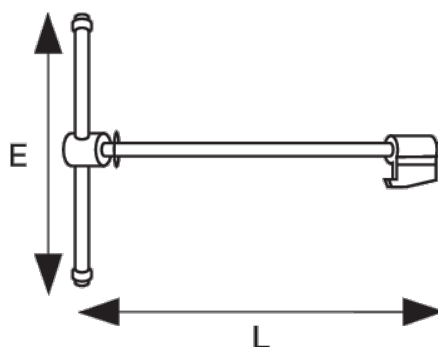

PRODUCT ATTRIBUTES

Product		E	L	
202811	80 mm	200 mm	251 mm	875 g