



206821

Spindle & Nut for Square Guide
Bench Vices 207041/216041



PRODUCT DETAILS

- Spare spindle and nut for square guide vice 207041/207071 and 216

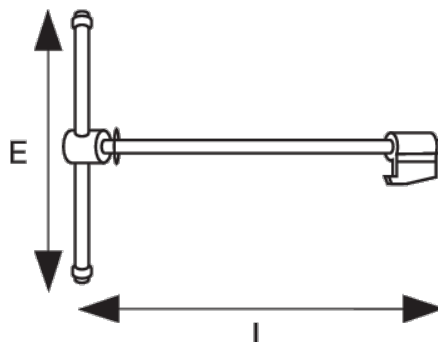

PRODUCT ATTRIBUTES

Product		E	L	
206821	100 mm	240 mm	287 mm	600 g