



202841

Spinotto e dado per morsa da banco
con guida rotonda 201261



DETTAGLI PRODOTTO

- Spinotto e bullone di ricambio per morsa con guida rotonda 201

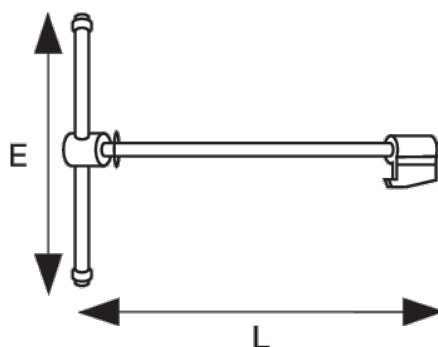

ATTRIBUTI PRODOTTO

Prodotto		E	L	
202841	150 mm	310 mm	428 mm	3400 g