



202811

Husillo y tuerca para tornillo de banco de guía redonda 201231



DETALLES DEL PRODUCTO

- Husillo y perno de repuesto para tornillo de banco de guía redonda 201.

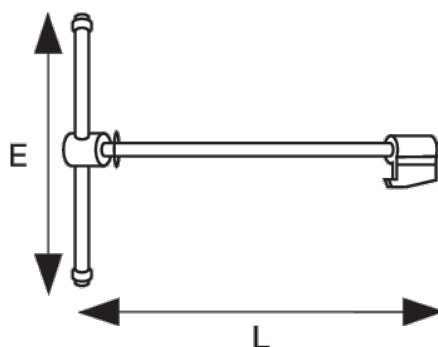

ATRIBUTOS DE PRODUCTO

Producto		E	L	
202811	80 mm	200 mm	251 mm	875 g