



202811

Mandril e porca para torno de bancada com guia redondo 201231



DETALHES DO PRODUTO

- Alavanca e parafuso sobresselentes para tornos de bancada redondos 201

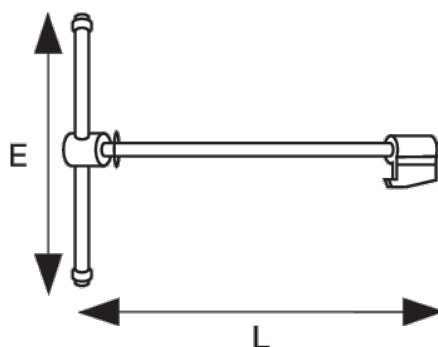

ATRIBUTOS DO PRODUTO

Produto		E	L	
202811	80 mm	200 mm	251 mm	875 g