



206821

Mandril e porca para tornos de bancada com guia quadrados 207041/216041



#### DETALHES DO PRODUTO

- Fuso e porca sobresselentes para tornos de guia quadrados 207041/207071 e 216

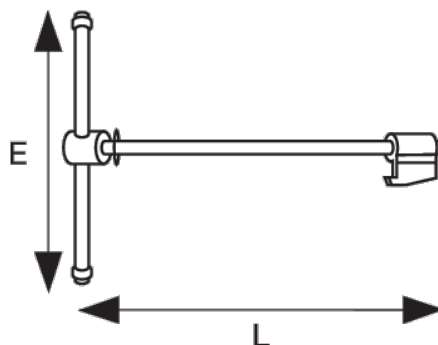

#### ATRIBUTOS DO PRODUTO

Produto		<b>E</b>	<b>L</b>	
206821	100 mm	240 mm	287 mm	600 g