



531-05-2



Marreta com pega de madeira 1000 g

DETALHES DO PRODUTO

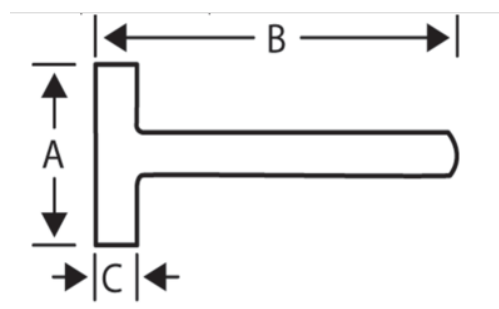
- Marreta
- Punho para cabeça de marreta com duas cunhas metálicas redondas
- Com cabo genuíno de noqueira
- Conjunto industrial:



ATRIBUTOS DO PRODUTO

Produto		A	B	L	
531-05-2	1000 g	40 mm	95 mm	260 mm	1155 g