



531-08-2



Marreta com pega de madeira 1500 g

DETALHES DO PRODUTO

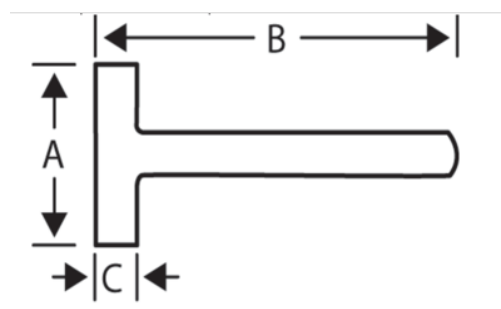
- Marreta
- Punho para cabeça de marreta com duas cunhas metálicas redondas
- Com cabo genuíno de noqueira
- Conjunto industrial:



ATRIBUTOS DO PRODUTO

Produto		A	B	L	
531-08-2	1500 g	45 mm	110 mm	280 mm	1675 g