



531-09-2

Marreta com pega de madeira 2000 g

DETALHES DO PRODUTO

- Marreta
- Punho para cabeça de marreta com duas cunhas metálicas redondas
- Com cabo genuíno de noqueira
- Conjunto industrial:

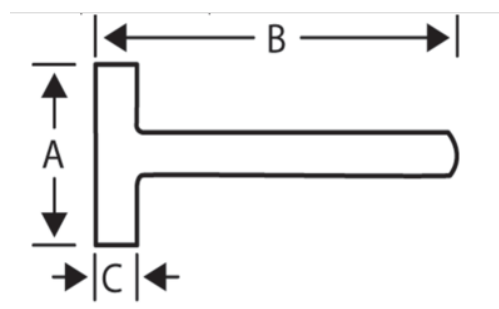

ATRIBUTOS DO PRODUTO

Produto		A	B	L	
531-09-2	2000 g	50 mm	120 mm	300 mm	2235 g